

Conventions of Orthographic Views

Projection Planes and Quadrants

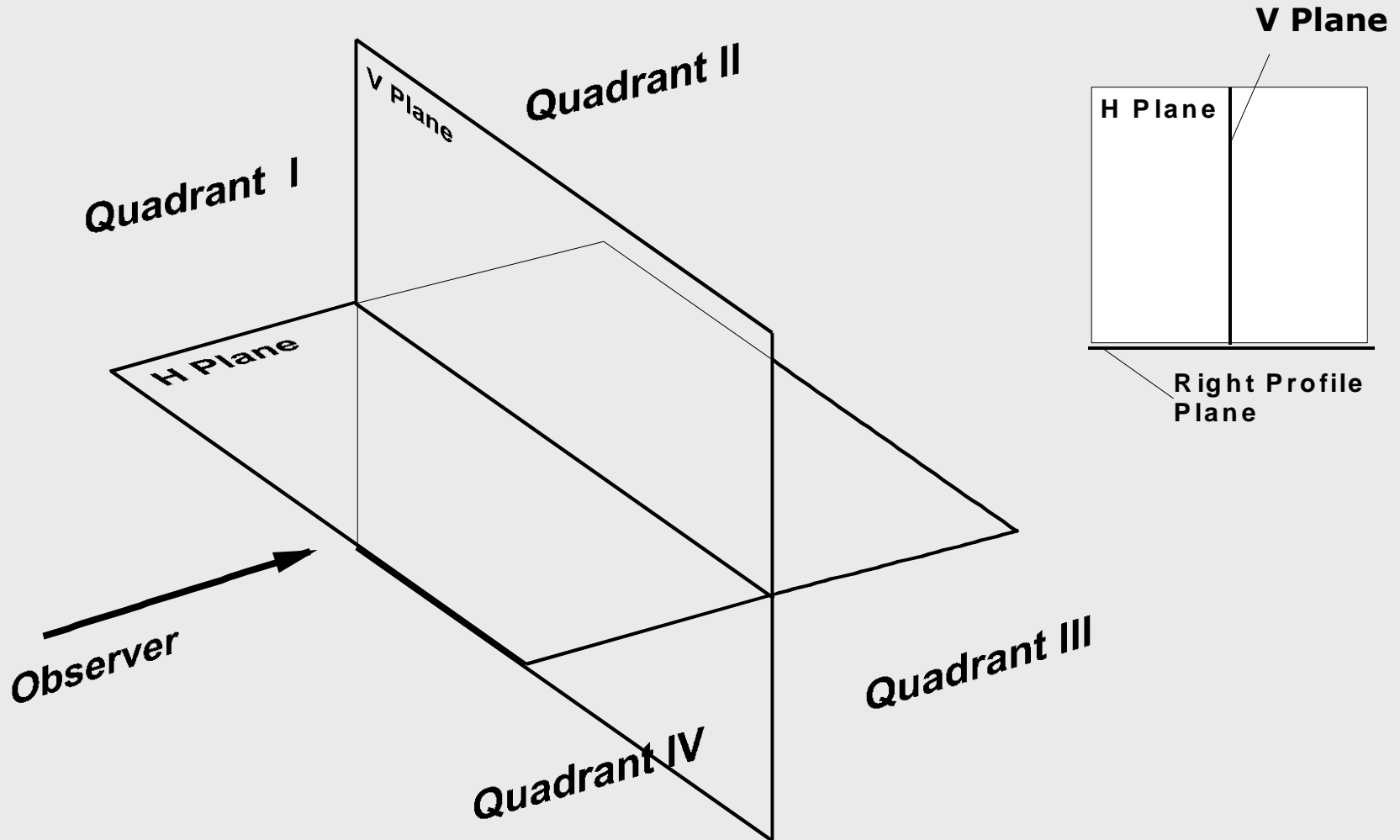

Conventions of Orthographic Views

First Angle Projection
standard in EU/Asia

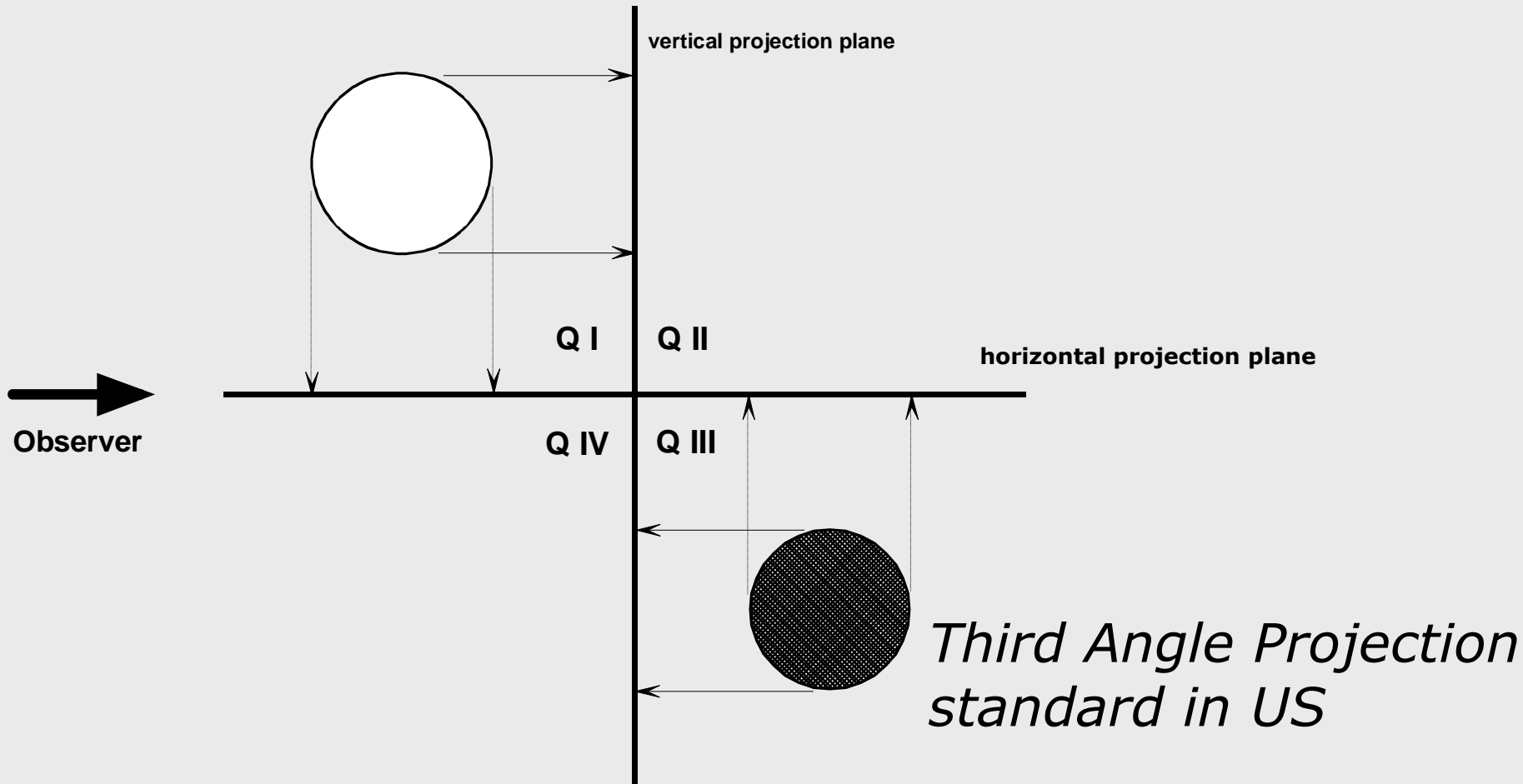

Conventions of Orthographic Views

Flipping of planes into Front View (Vertical) Plane for drawing onto a sheet of paper

THIRD ANGLE

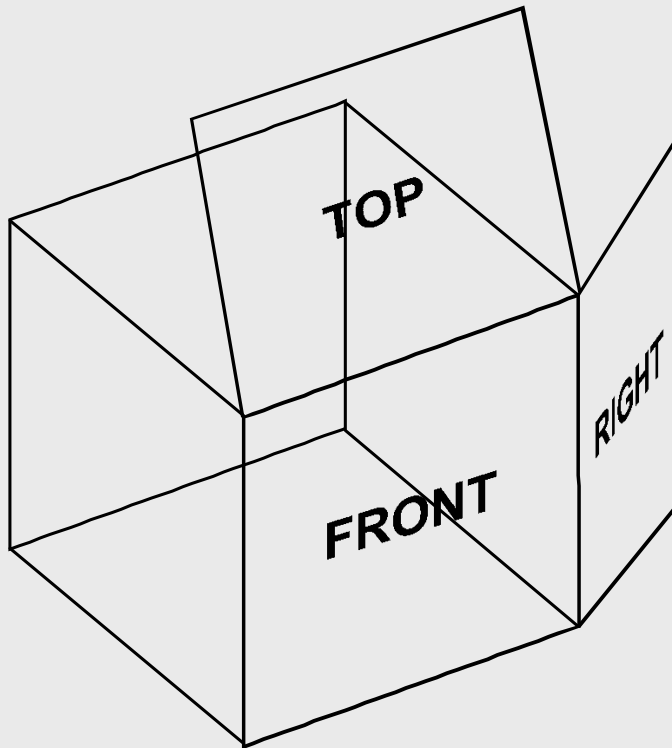

FIRST ANGLE

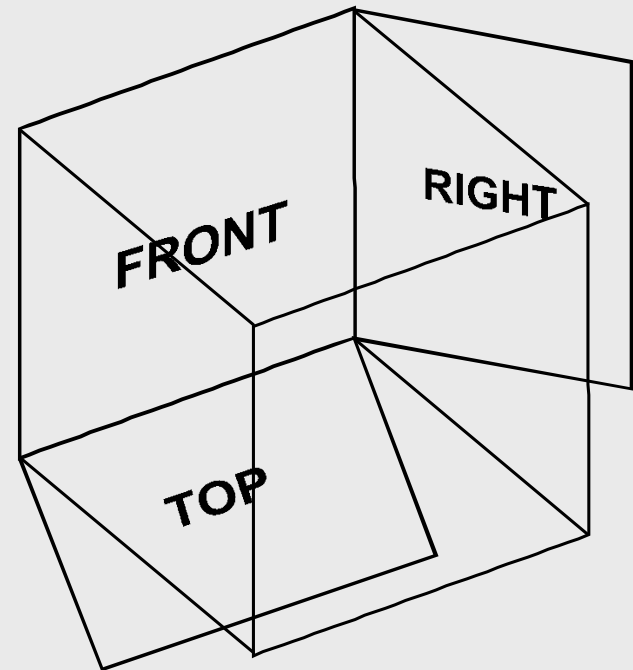

Conventions of Orthographic Views

Third Angle Views of an Object

Top

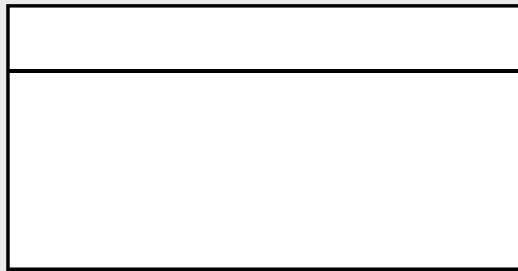

Front

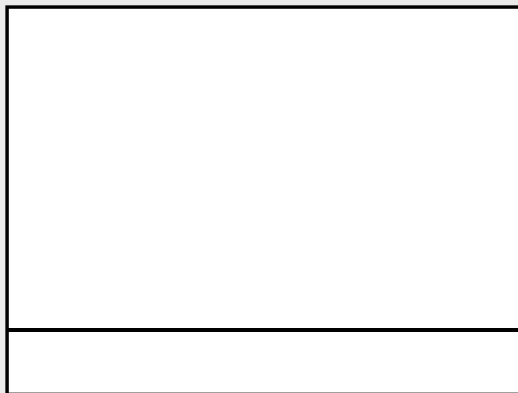

Right

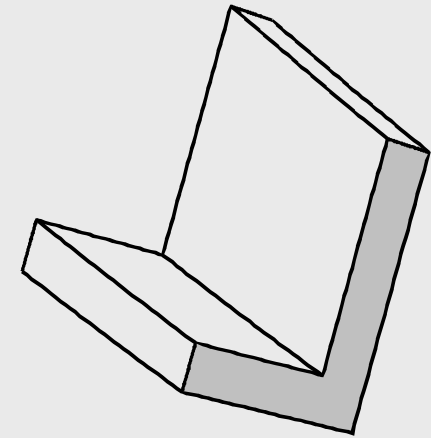

Conventions of Orthographic Views

Engineering Drawing in third angle projection

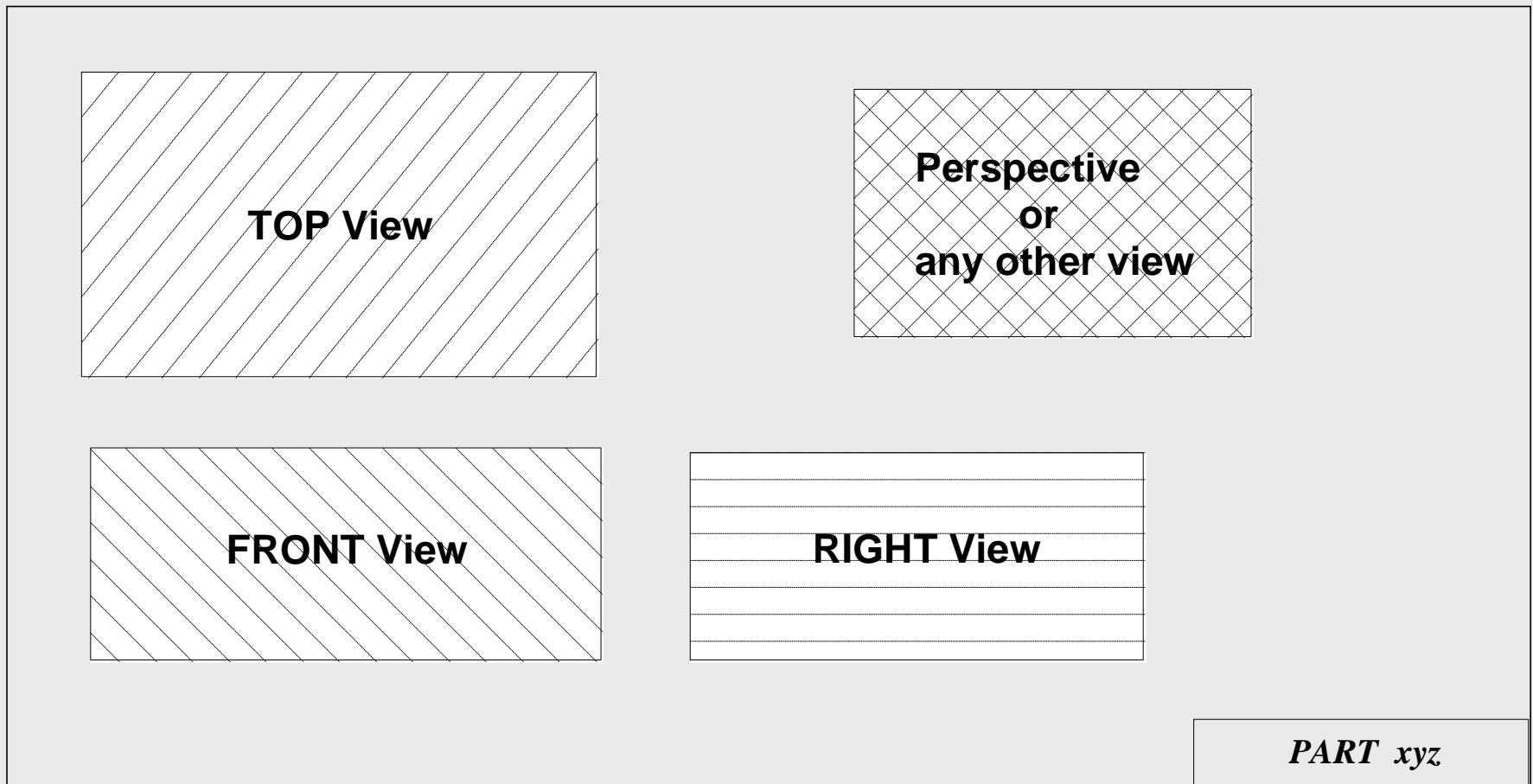

Conventions of Orthographic Views

Engineering Drawing in first angle projection

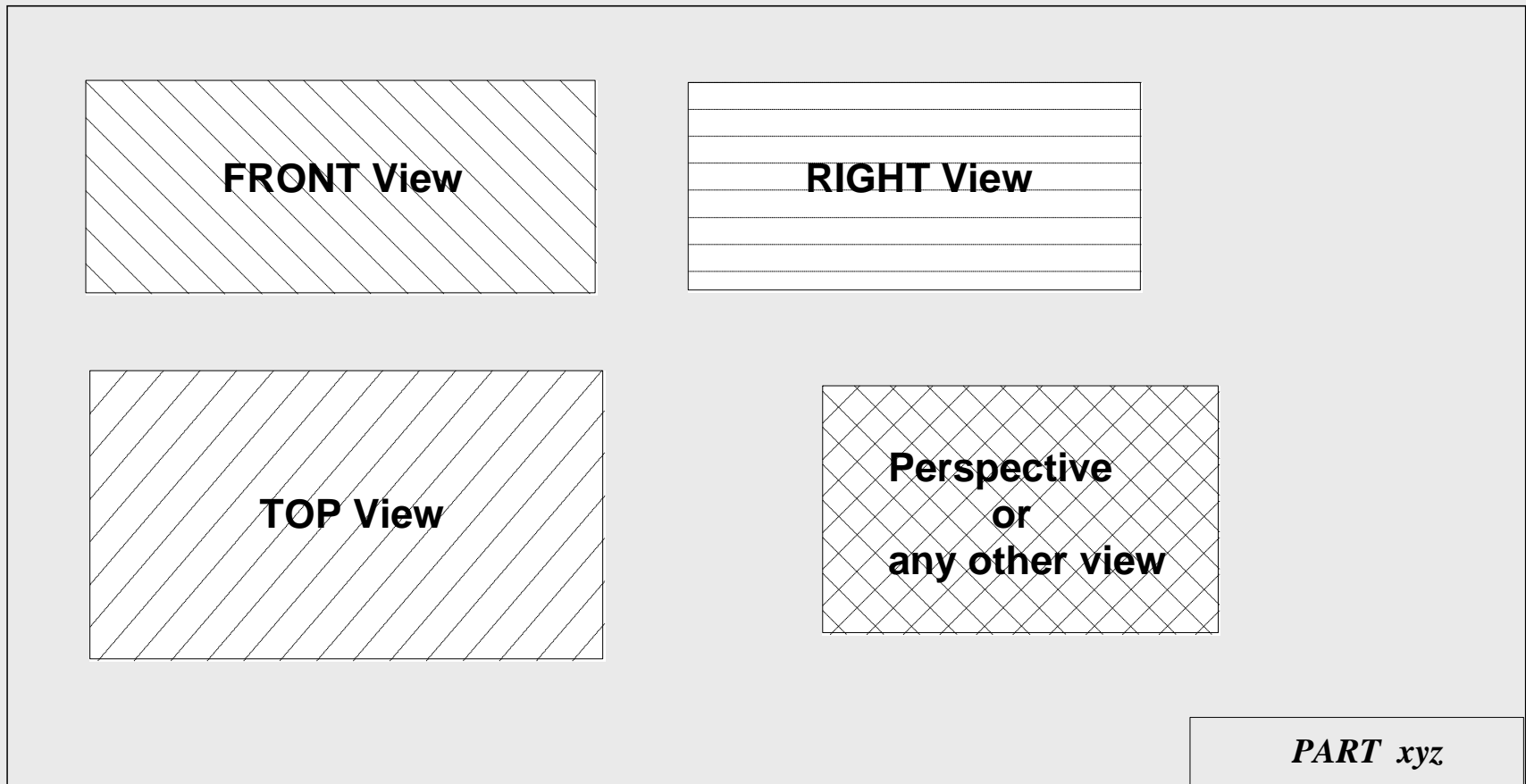

Conventions of Orthographic Views

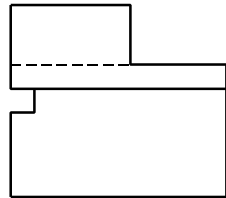

Third Angle Views

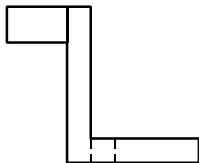
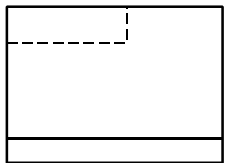
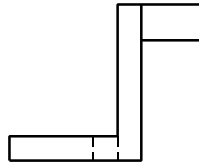
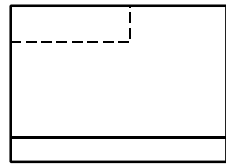

First Angle Views

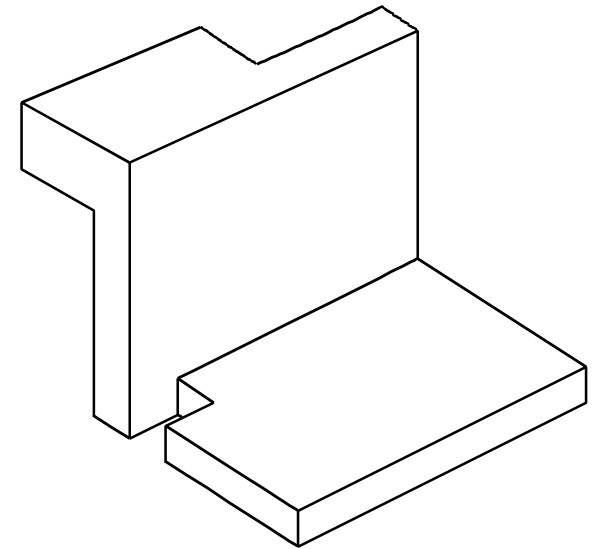
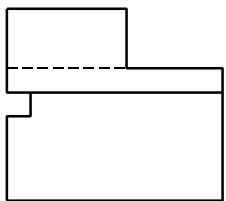

Perspective View